

Scissors and Fine Motor Skills Practice

Hajj

Activity Book for Little Kids

Jameela Ho

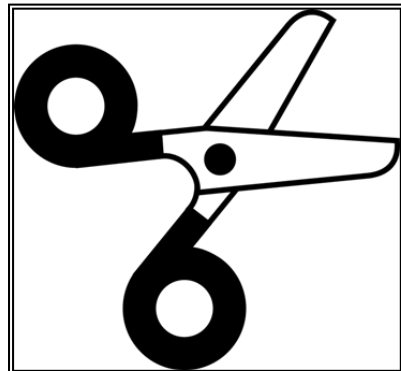
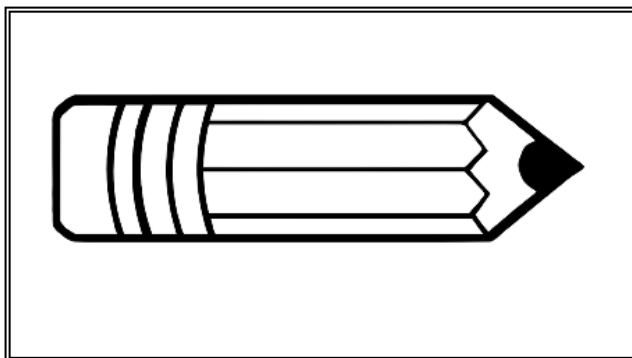

It's time for hajj. Let's go by plane to Makkah.

Colour the picture. Cut and paste the plane over the map of Saudi Arabia.

Jameela Ho <http://ilmaeducation.blogspot.com.au>

First, we must tawaf around the Ka'bah seven times. Trace the path around the Ka'bah.

Jameela Ho <http://ilmaeducation.blogspot.com.au>

We're at Arafat to make dua. Find your way through the tents to Mount Arafat by drawing a line from the arrow to the mount.

Start Here →

Jameela Ho <http://ilmaeducation.blogspot.com.au>

It's time for hajj. Let's go by plane to Makkah.

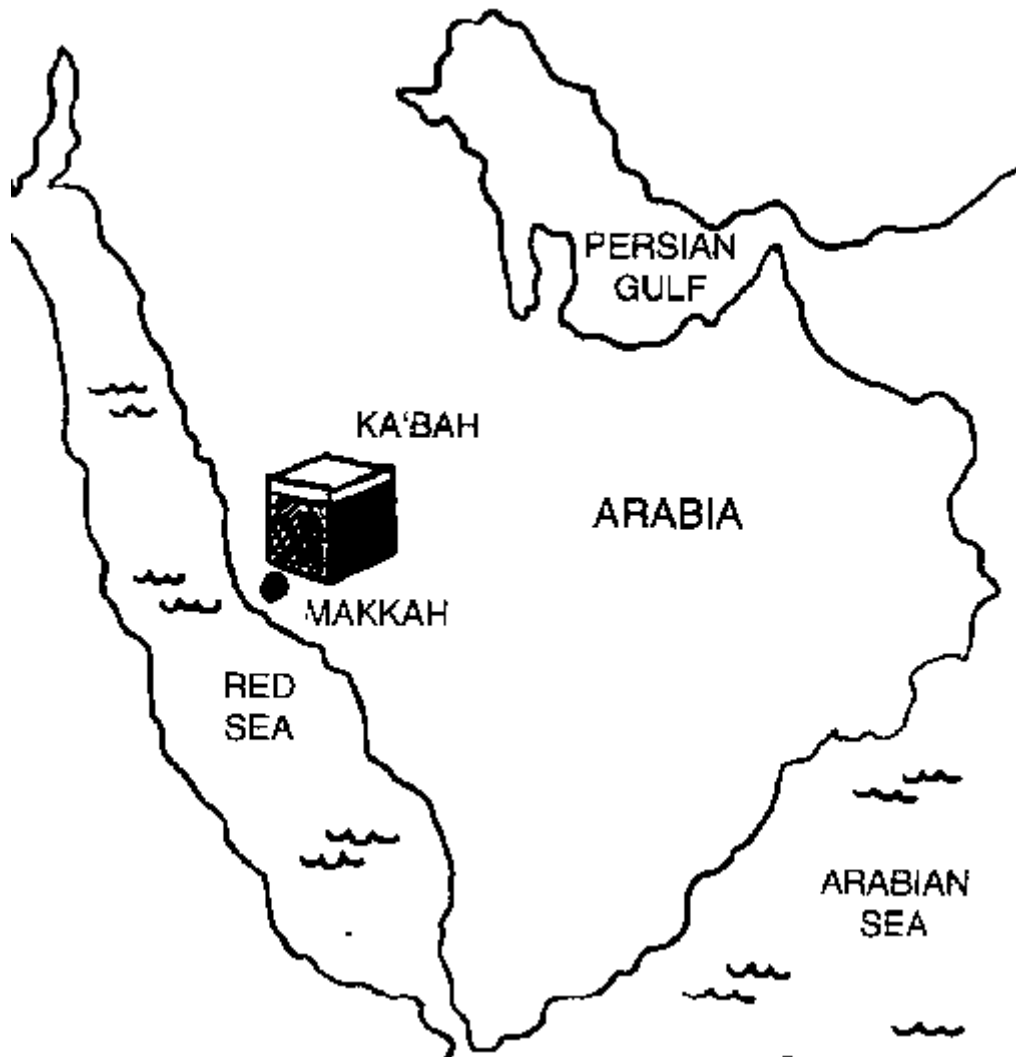

Colour the picture. Cut and paste the plane over the map of Saudi Arabia.

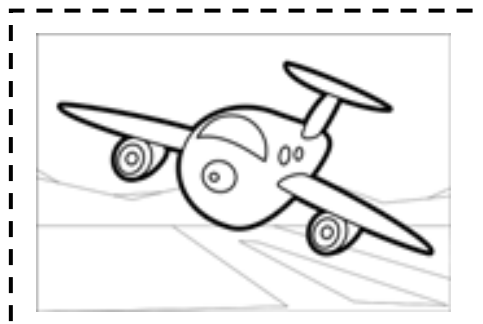

Then get on the bus to take us to the Ka'bah.

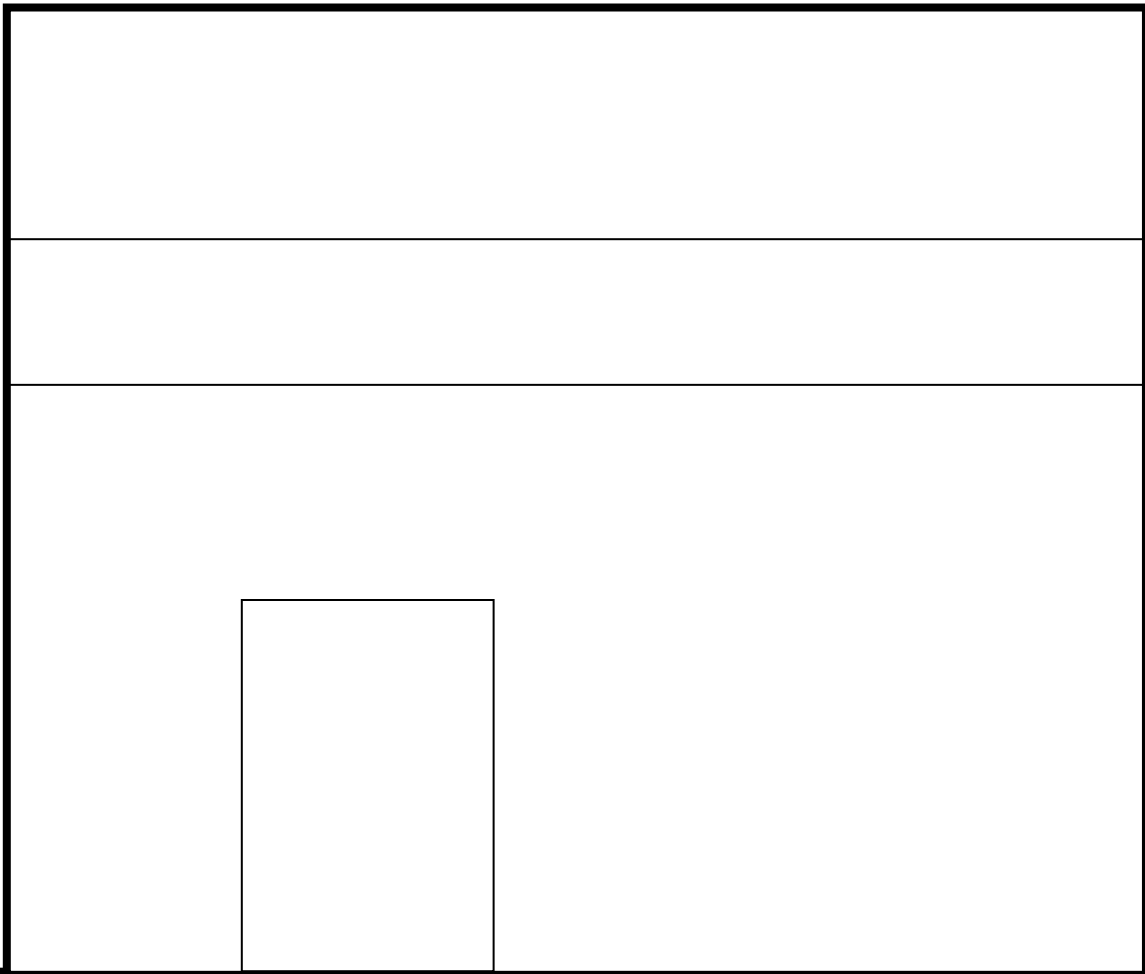

Colour the picture. Cut and paste the bus in front of the Ka'bah.

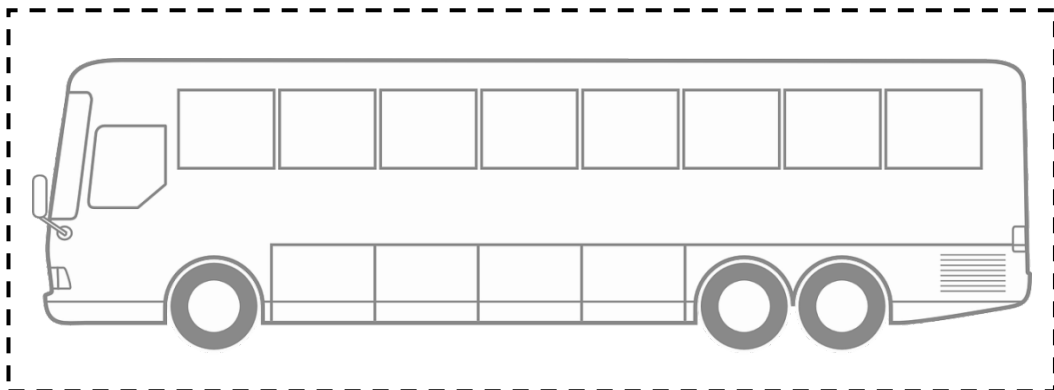

First, we must tawaf around the Ka'bah seven times. Trace the path around the Ka'abh.

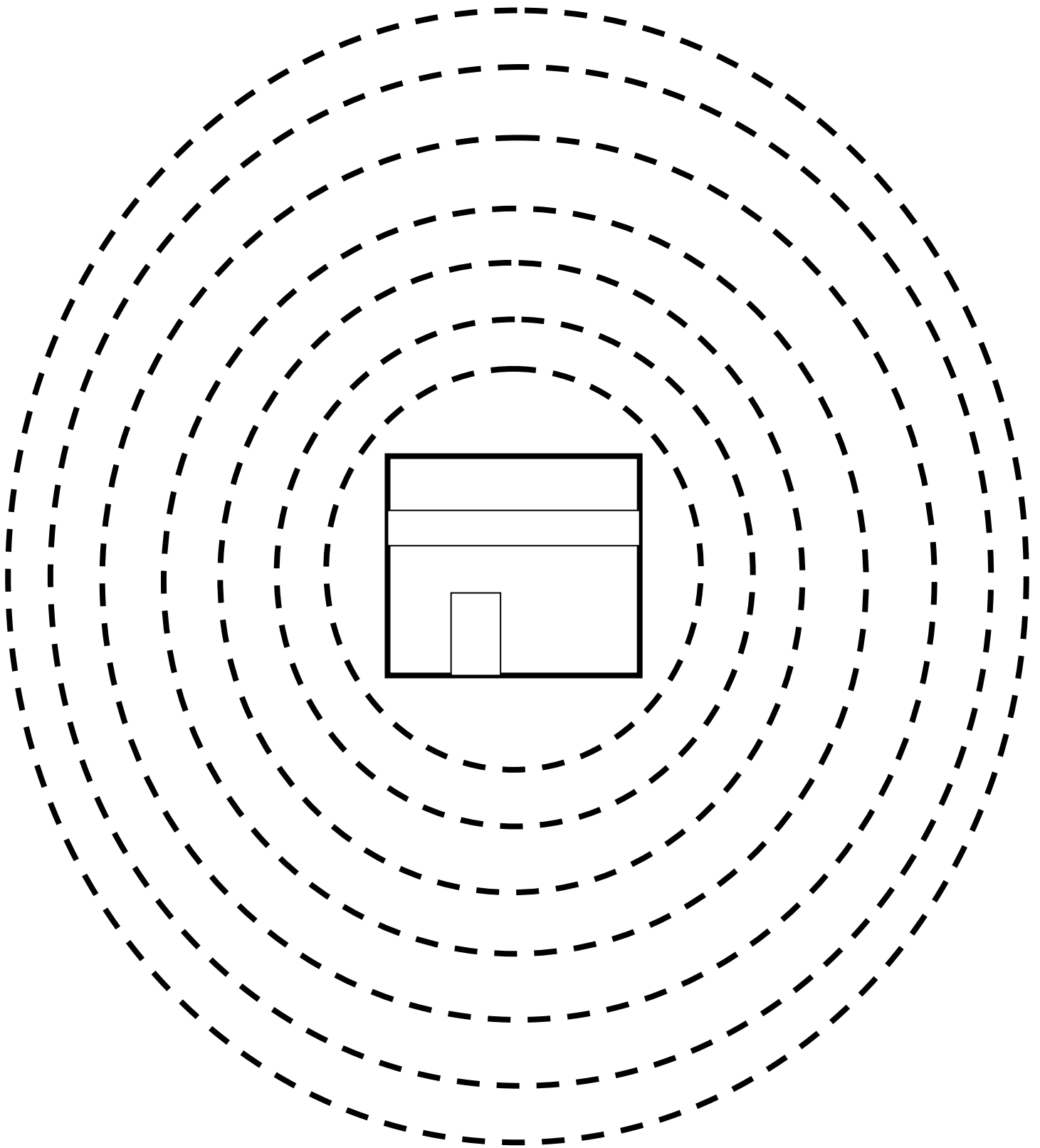

Then run from Mount Safa to Marwah and back again seven times. Trace the path between the two mounts.

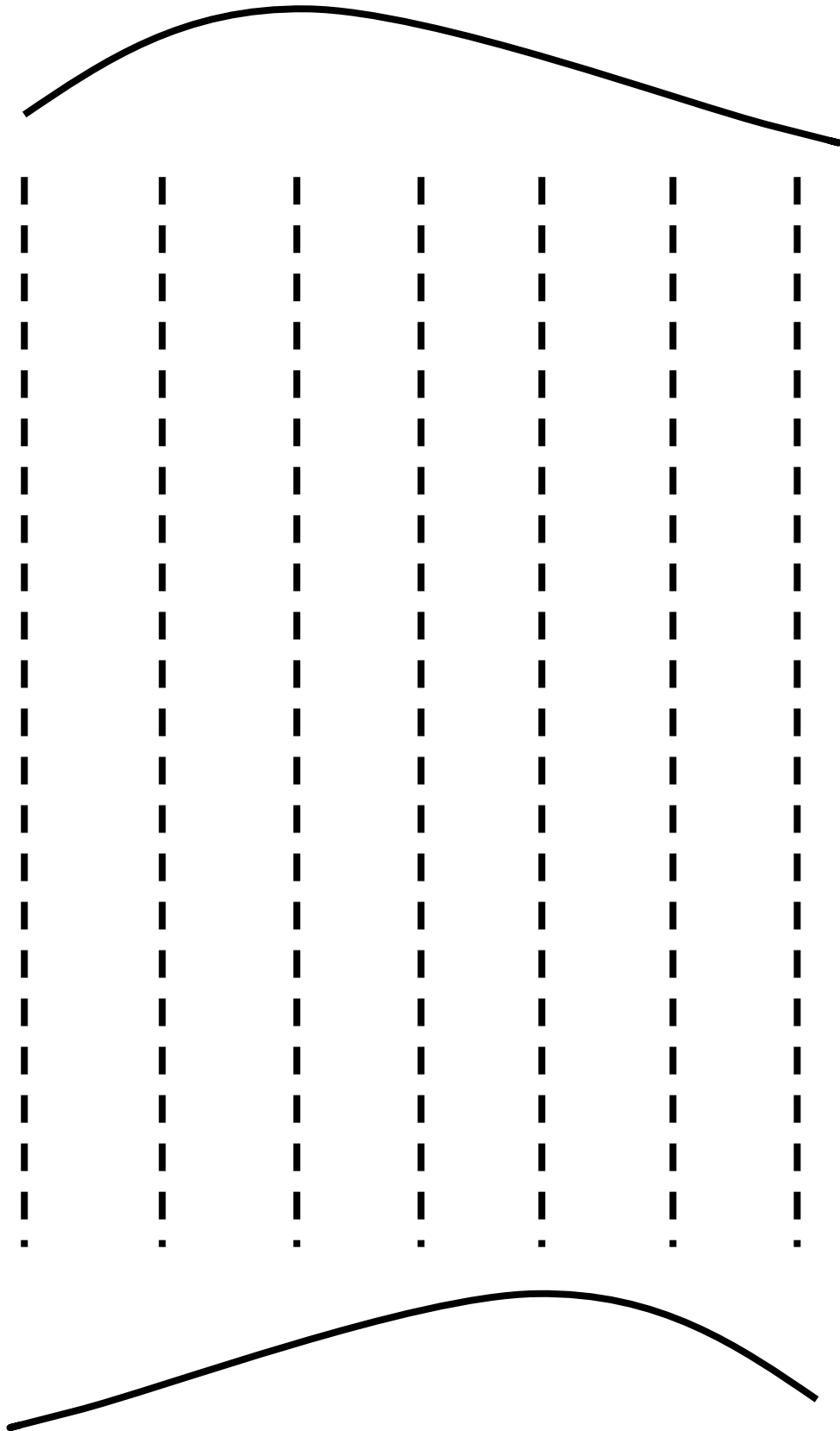

After all that walking and running, we need a drink of zamzam water. Trace the lines on the zamzam cup.

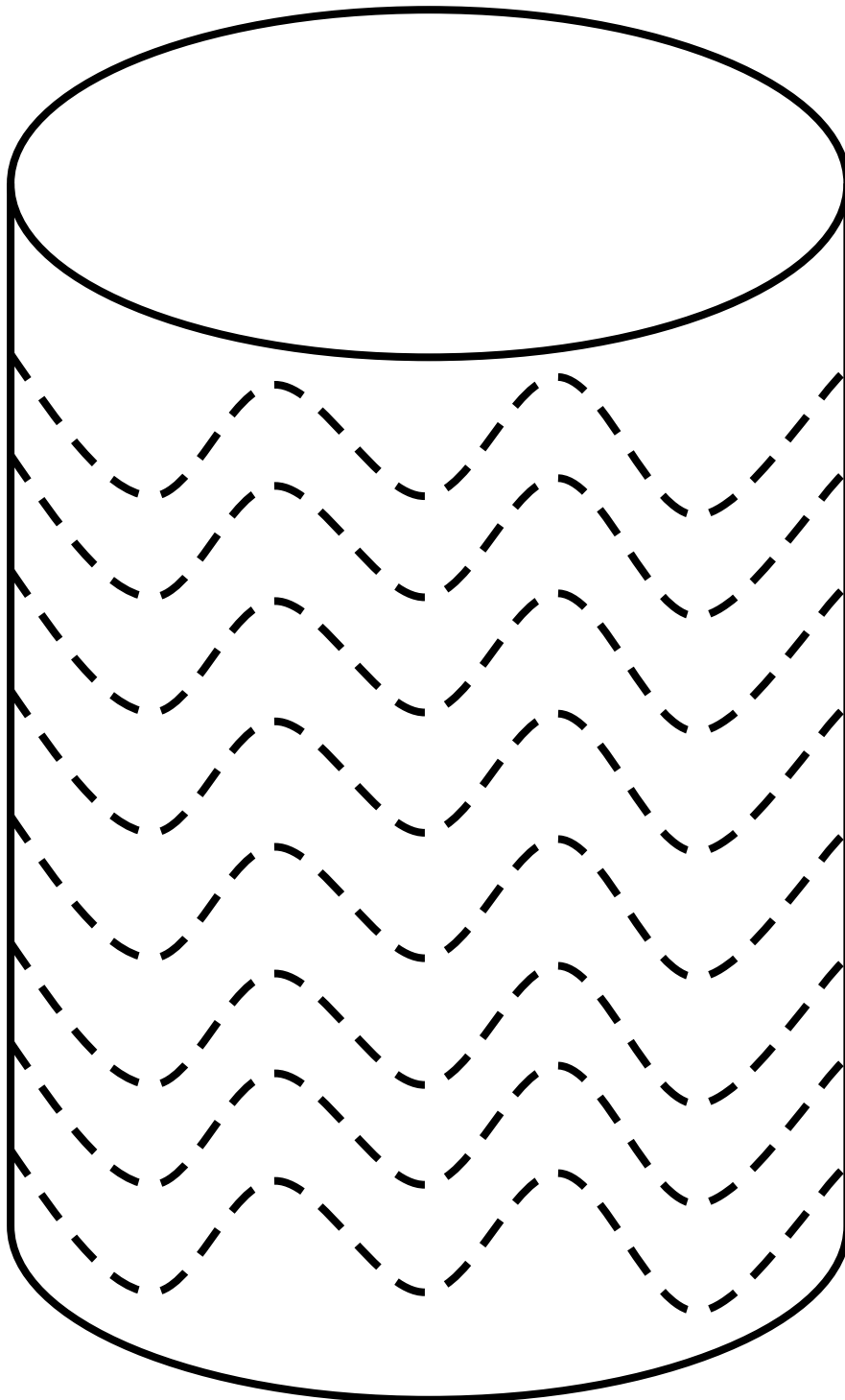

It's time to sit down and read the Qur'an. Trace and colour the Qur'an.

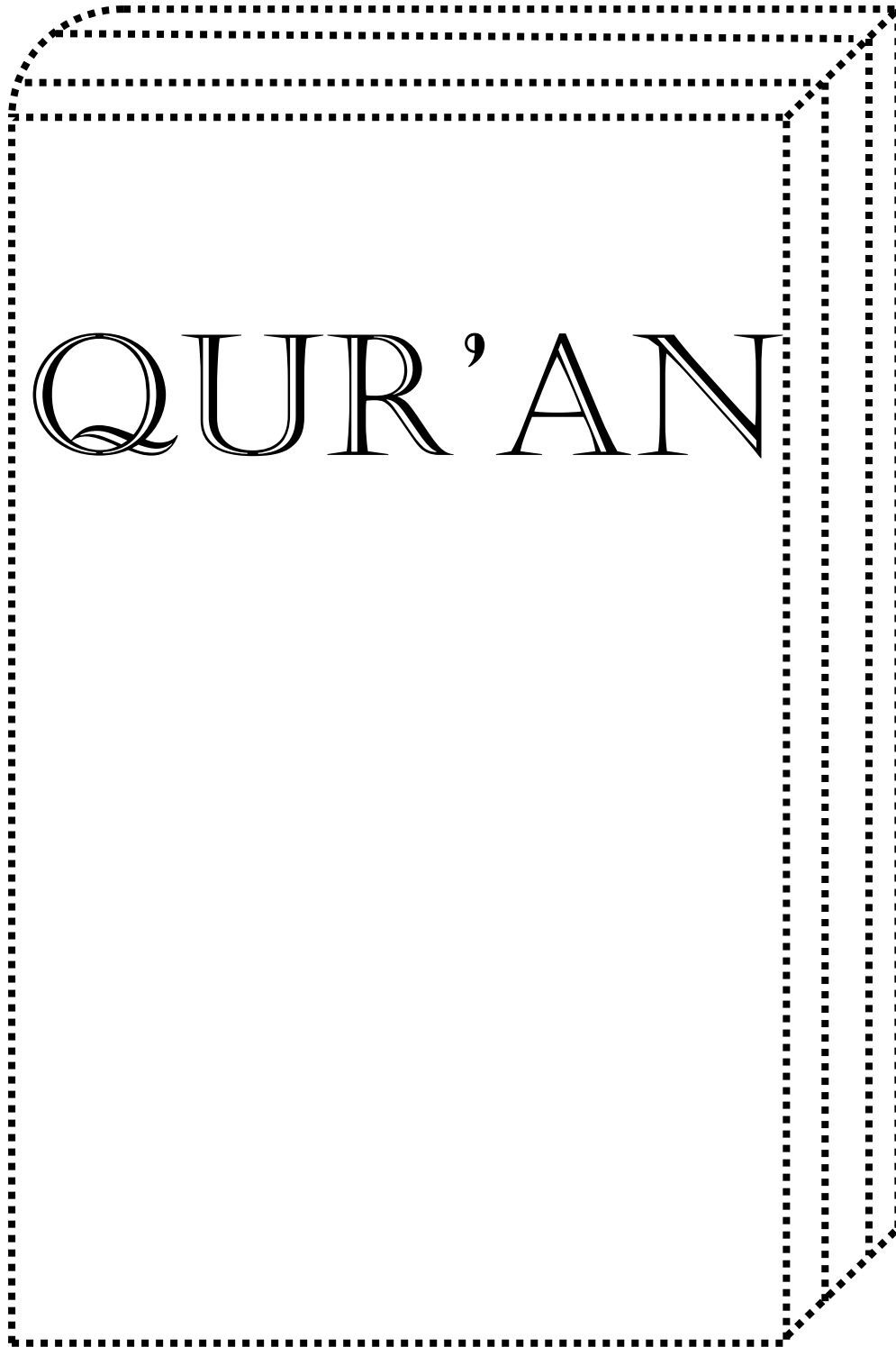

We hear the call to prayer so it's time to pray at the Ka'bah.
Decorate and colour the prayer mats.

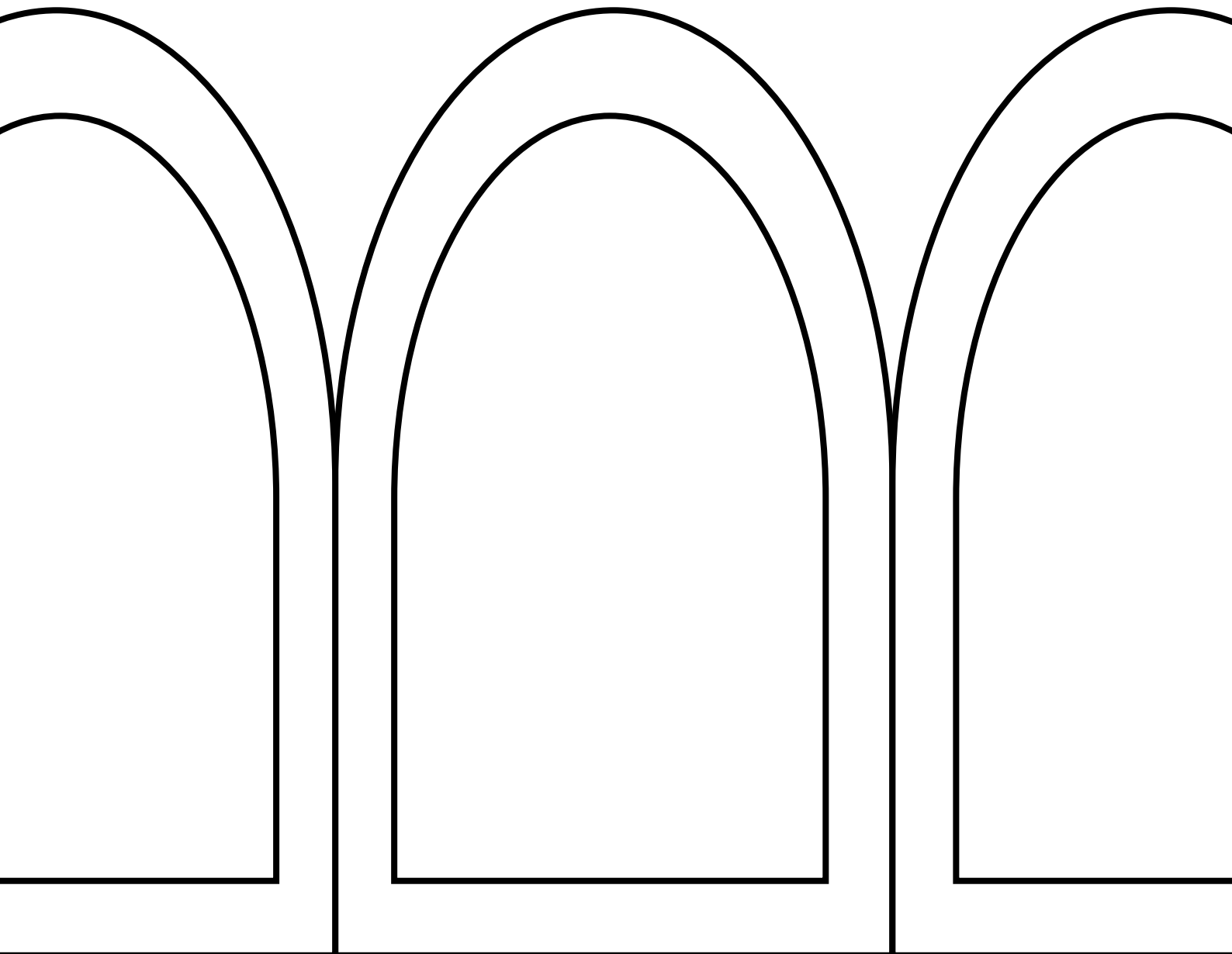
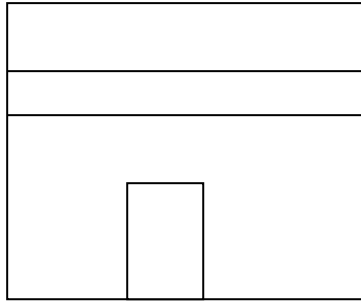

Next, it's time to throw stones at the Jamrah. First we must find seven stones. Count and match the number of stones. Then circle the seven stones.

○
○
○
○
○
○
○

1

2

3

4

5

6

7

○	
○	○
○	○
○	○
○	○
○	○
○	○
○	○
○	○

We're at Arafat to make dua. Find your way through the tents to Mount Arafat by drawing a line from the arrow to the mount.

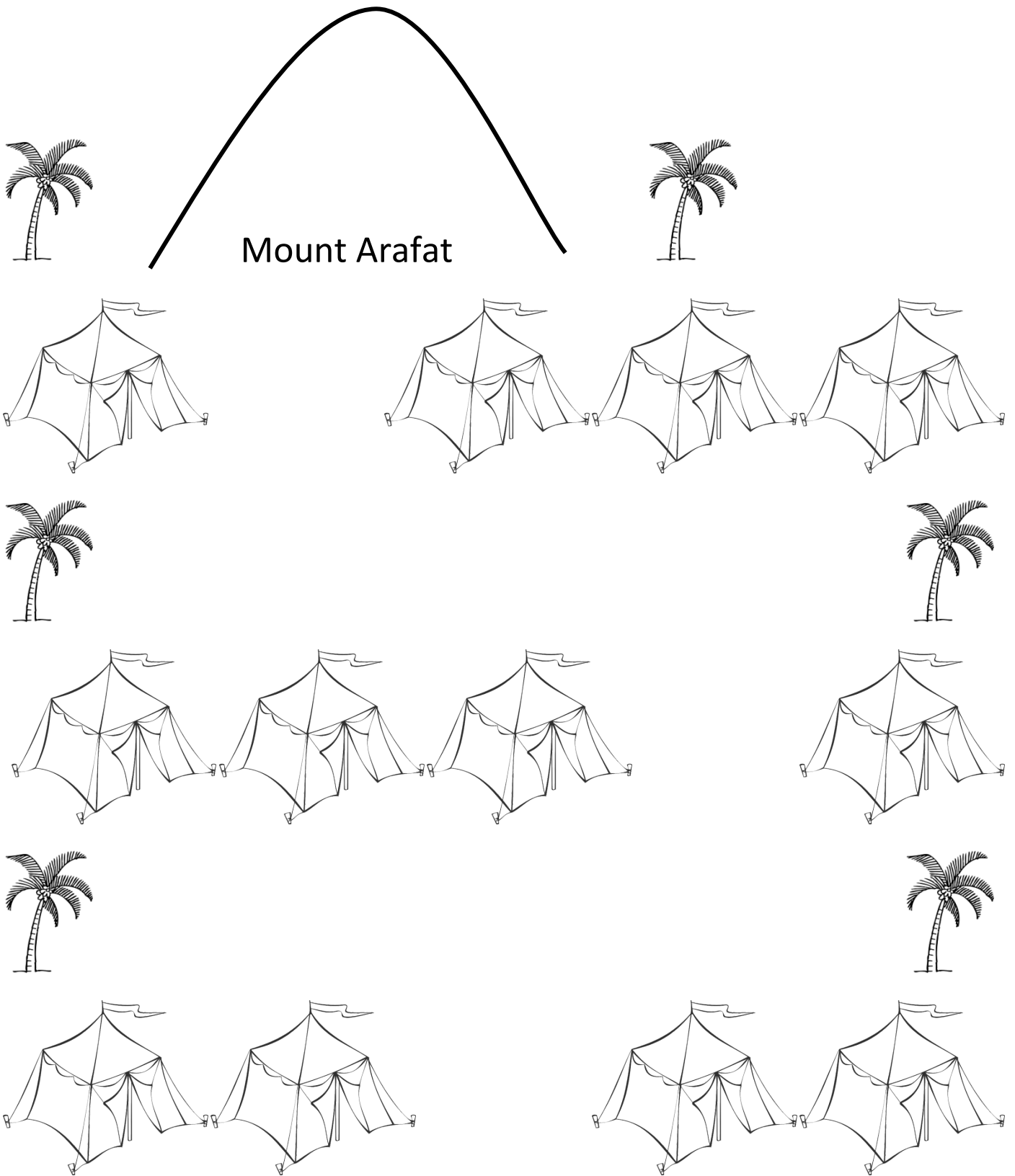

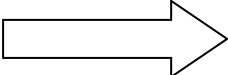
Start Here 

It's Eid! Choose your sheep for qurban. Trace the dashed lines.

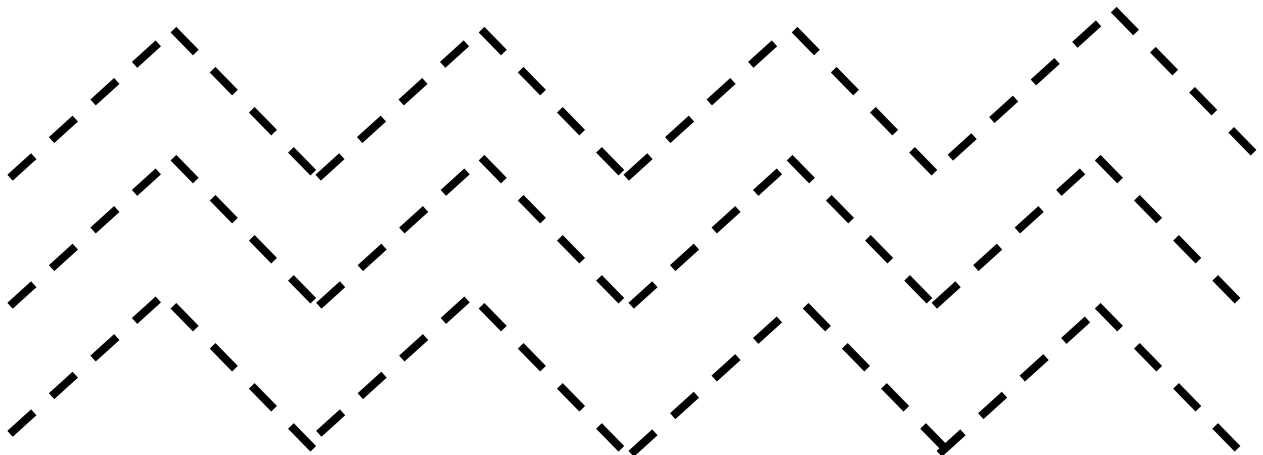
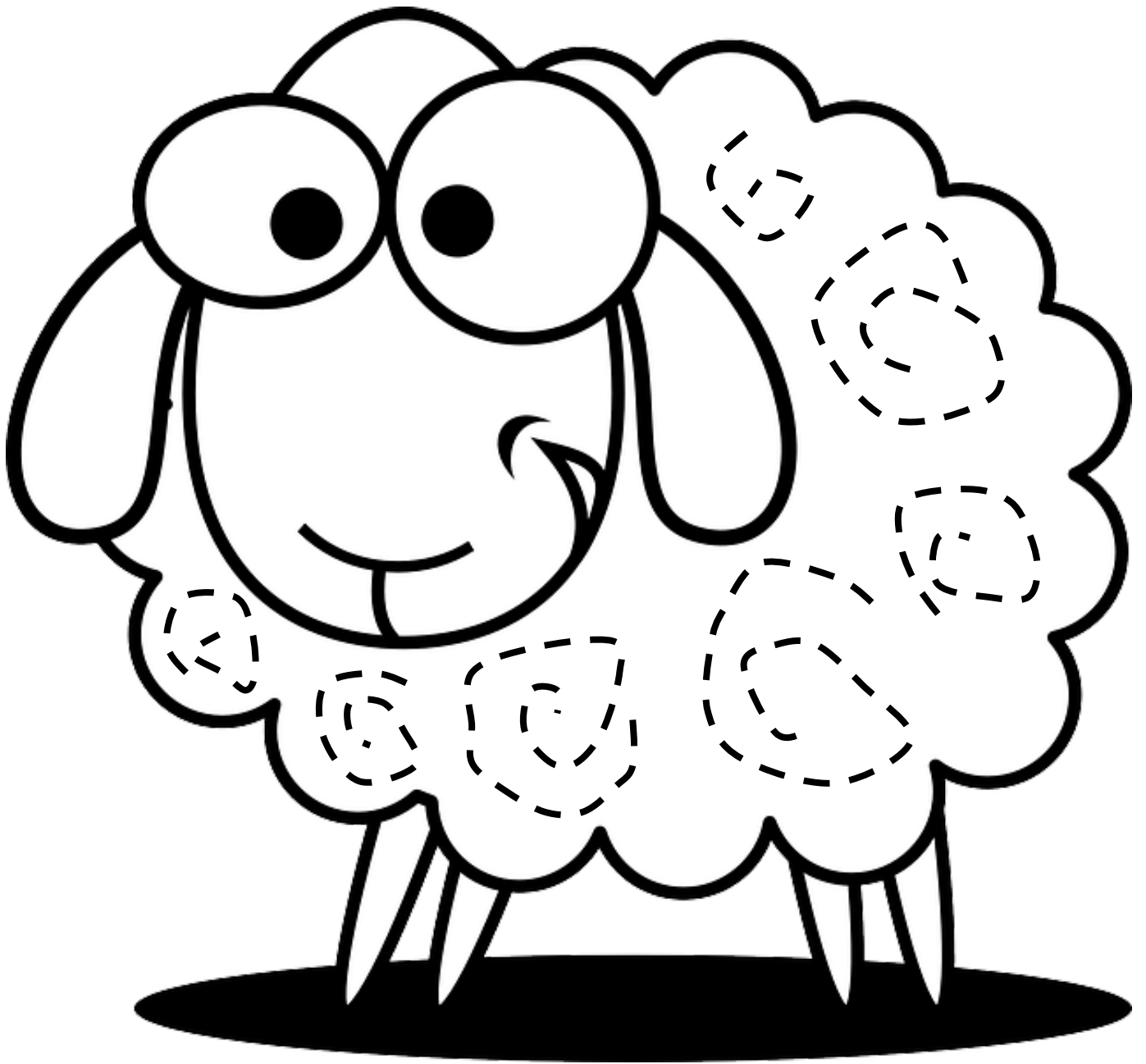

Don't forget to pray at the Prophet's Mosque in Madinah. Trace then colour in the mosque.

